

LES MOBILIERS DU VIN

THE WINE CABINETS

L'ATELIER DU VIN

FRANCE 1926

WINE TOOLS FOR CONNOISSEURS



LES MEUBLES

L'Atelier du Vin vous présente ses solutions techniques et esthétiques pour la « maison » : mobiliers de service & d'accueil, dotés de généreux comptoirs pour toutes vos dégustations, ou table basse facile à installer dans le salon et les espaces d'accueil.

—

L'Atelier du Vin introduces technical & aesthetical « home » solutions : contemporary furnitures equipped with generous countertops, wide coffee tables for wine and spirits. Easy to install in the living-room and reception areas.

Printemps / Spring 2016
MAJ / Update 25.03.2016

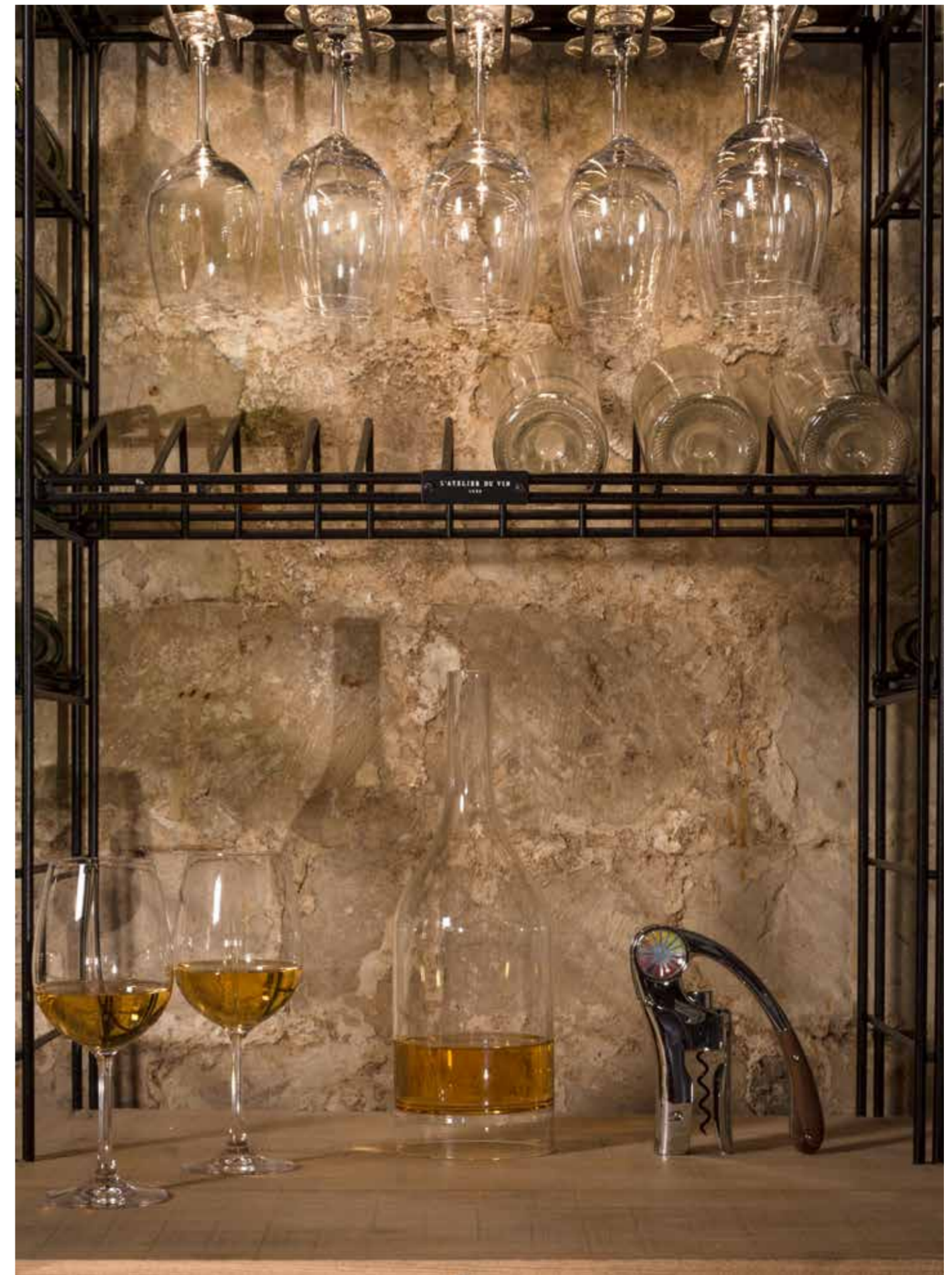

Les Caves/The Cellars : MARCHAND DE VIN/WINE MERCHANT
Verres/Wine glasses : L'EXPLOREUR CLASSIC
Tire-bouchon/Corkscrew : OENO MOTION WOOD
Carafe/Carafe : PERCHÉE/PERCHED

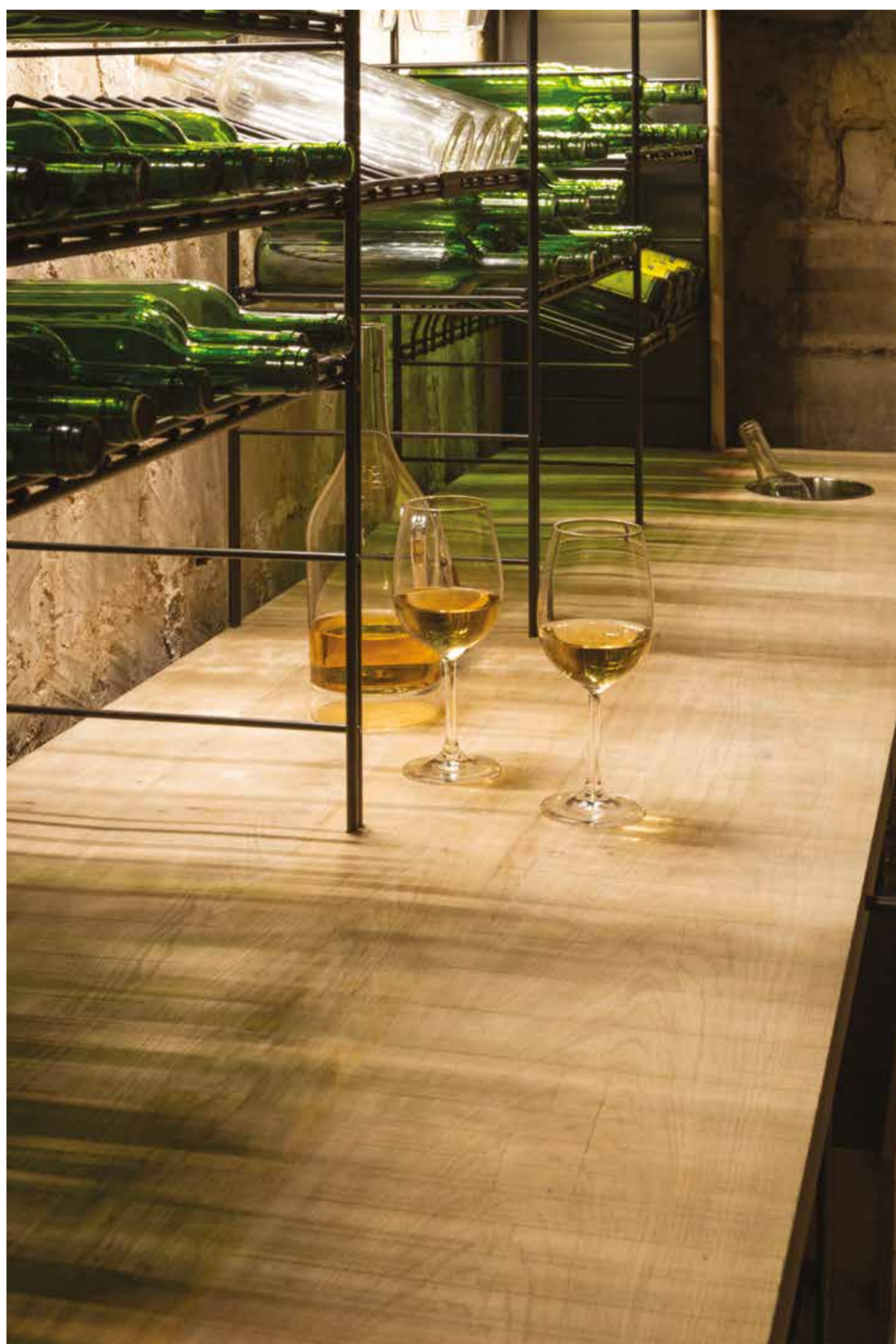

Les Caves/The Cellars : MARCHAND DE VIN/WINE MERCHANT
Verres/Wine glasses : L'EXPLORER CLASSIC
Tire-bouchon/Corkscrew : OENO MOTION WOOD
Carafe/Carafe : PERCHÉE/PERCHED

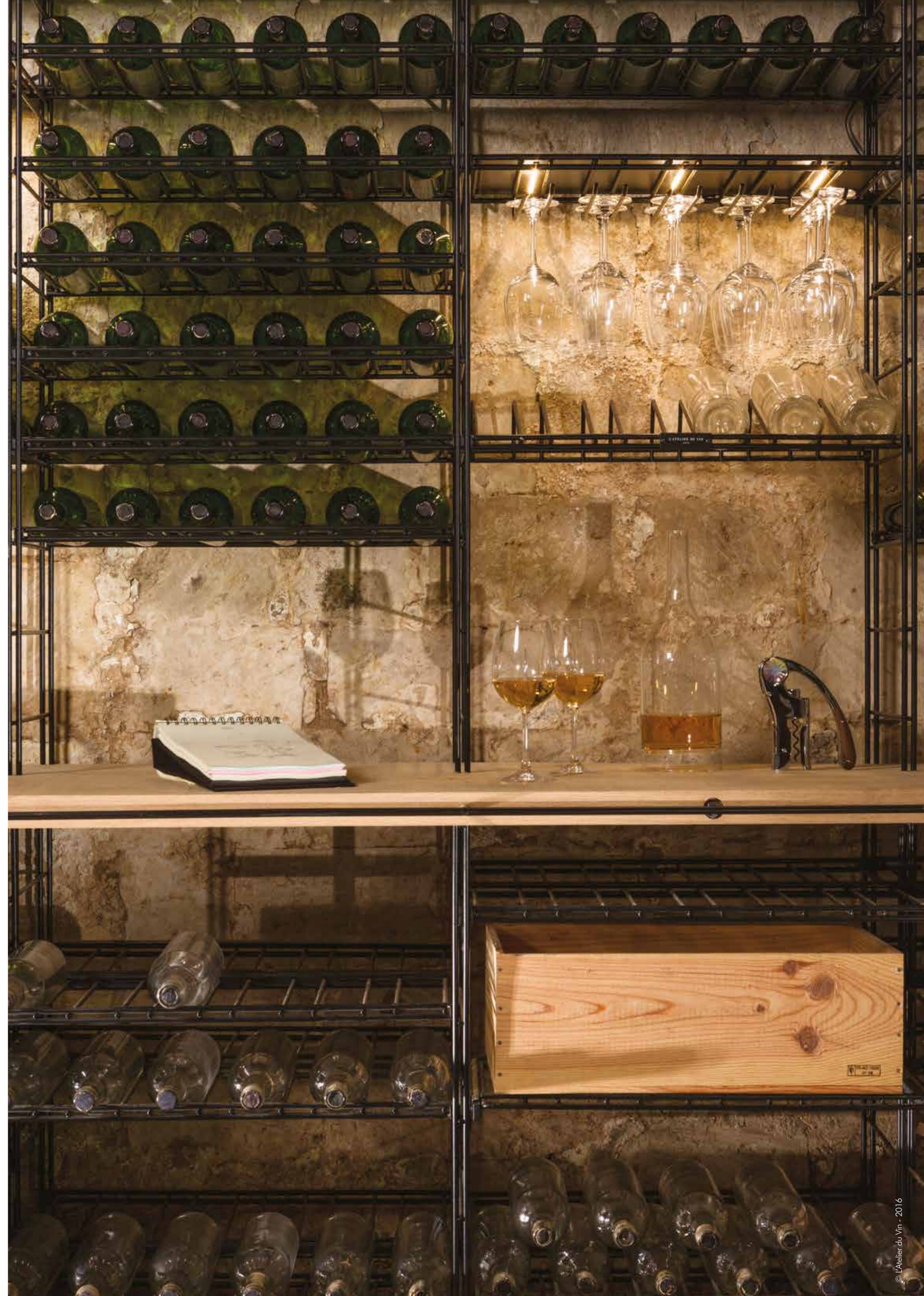



Les Caves/The Cellars : MARCHAND DE VIN/WINE MERCHANT
Verres/Wine glasses : L'EXPLOREUR CLASSIC
Tire-bouchon/Corkscrew : OENO MOTION WOOD
Carafe/Carafe : PERCHÉE/PERCHED



Ci-dessus
Meuble/Furniture : **PETIT BAR**

Ci-contre
Meuble/Furniture : **BUFFET FROID**



MARCHAND DE VIN

Marchand de Vin, doté d'un comptoir idéal pour toutes les dégustations, peut accueillir de 500 à 1000 bouteilles, en fonction de la configuration des modules choisis.
Toutes les tablettes complémentaires des Caves sont compatibles avec Le Marchand de Vin.
Fabriqué en acier peint anti-corrosion et en bois massif.

*Wine Merchant is equipped with a generous countertop ideal for all wine tastings and can accommodate from 500 to 1000 bottles, depending on the configuration that has been chosen.
All the complementary shelves of Cellars are compatible with the Wine Merchant.
Made from anti-corrosion painted steel and solid wood.*

Option Cave de service : l'un des deux espaces inférieurs peut recevoir une cave à vin de service. Sur demande.
Option: a wine cabinet can be placed in one of the under worktop spaces. On request.

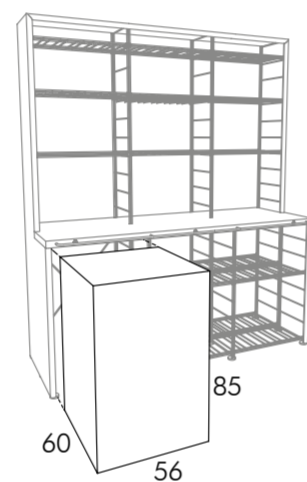

Dimensions maximales de la cave de service : L 56 x P 60 x H 85 cm
Maximal sizes for the wine cabinet: W 56 x D 60 x H 85 cm



BUFFET FROID

Mobilier contemporain de service et d'accueil.
Cave à vin, bar à alcools, rack à verres, espace livres, plan de travail pour partager fromages, jambons et snacks.
Toutes les tablettes complémentaires des Caves sont compatibles avec le Buffet Froid.
Matériaux : acier peint anti-corrosion et plateau stratifié ou plaqué bois.

*Contemporary furniture including wine storage, a cocktail bar, a stemware rack, book shelves, and a worktop to share cheese, ham and snacks.
All the complementary shelves of Cellars are compatible with the Buffet Froid.
Made from anti corrosion painted steel and laminated panel.*

Option Cave de service : l'un des deux espaces inférieurs peut recevoir une cave à vin de service. Sur demande.
Option: a wine cabinet can be placed in one of the under worktop spaces. On request.

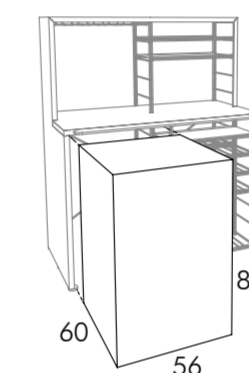

Dimensions maximales de la cave de service : L 56 x P 60 x H 85 cm
Maximal sizes for the wine cabinet: W 56 x D 60 x H 85 cm

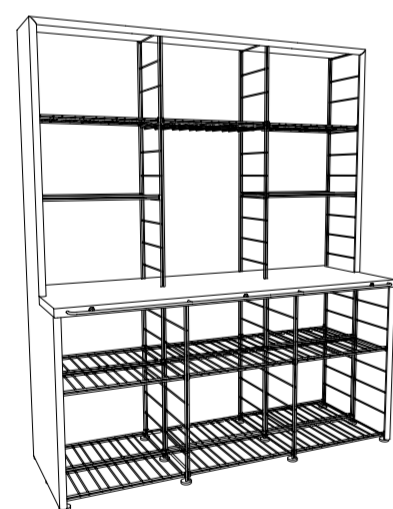

CONFIGURATION DE BASE
3 MODULES - ref : 095519-4
Tablette Horizontale : 16
Rack à Verres : 1
Plaque Métal pour tablette : 2
L 183 x (P_b 70 ; P_h 35) x H 216 cm

BASIC CONFIGURATION
3 MODULES - ref : 095519-4
Shelf : 16
Glass rack : 1
Metal plate for shelf : 2
W 183 x (D_i 70 ; D_u 35) x H 216 cm

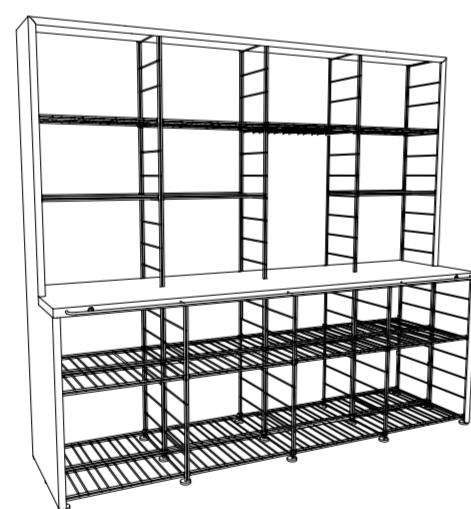

CONFIGURATION DE BASE
4 MODULES - ref : 095516-3
Tablette Horizontale : 22
Rack à Verres : 1
Plaque Métal pour tablette : 3
L 244 x (P_b 70 ; P_h 35) x H 216 cm

BASIC CONFIGURATION
4 MODULES - ref : 095516-3
Shelf : 22
Glass rack : 1
Metal plate for shelf : 3
W 244 x (D_i 70 ; D_u 35) x H 216 cm



CONFIGURATION DE BASE
5 MODULES - ref : 095484-5
Tablette Horizontale : 28
Rack à Verres : 1
Plaque Métal pour tablette : 4
L 305 x (P_b 70 ; P_h 35) x H 216 cm

BASIC CONFIGURATION
5 MODULES - ref : 095484-5
Shelf : 28
Glass rack : 1
Metal plate for shelf : 4
W 305 x (D_i 70 ; D_u 35) x H 216 cm

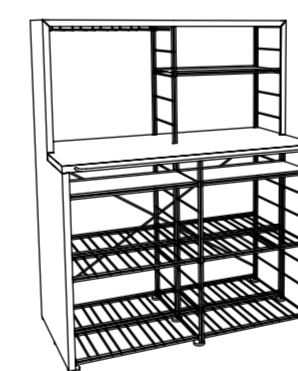

CONFIGURATION DE BASE
ref : 095510-1
Tablette Horizontale : 12
Rack à Verres : 1
Plaque Métal pour tablette : 3
L 123 x (P_b 70 ; P_h 35) x H 150 cm

BASIC CONFIGURATION
ref : 095510-1
Shelf : 12
Glass rack : 1
Metal plate for shelf : 3
W 123 x (D_i 70 ; D_u 35) x H 150 cm



Composition avec une cave de service, sur demande
Composition with a wine cabinet, on request



Côté bar à vin et champagne
On this side: wine and champagne bar

PETIT BAR

Table basse généreuse et très facile à installer dans le salon et les espaces d'accueil.
Côté vin : rack pour 6 bouteilles et rack pour verres à pied.
Côté alcools : espace cocktail bar et livres.
Matériaux : acier peint anti-corrosion et plateau plaqué bois.
Dimensions indicatives : L 57cm x l 57 cm x H 40,5 cm

Wide coffee table for wine and spirits, the Petit Bar Square is easy to install in the living-room and reception areas.
Wine section : rack for 6 bottles and stemware rack.
Spirit section : cocktail bar and book shelf.
Made from anti corrosion painted steel and laminated panel.
Dimensions (for information purpose only) : L 57cm x l 57cm x H 40,5cm

ref : 095509-5

 MONTAGE : 15min/1pers.
Mounting : 15min/1pers.

 TRANSPORT : L 67 x l 67 x H 23 cm
Flat transportation

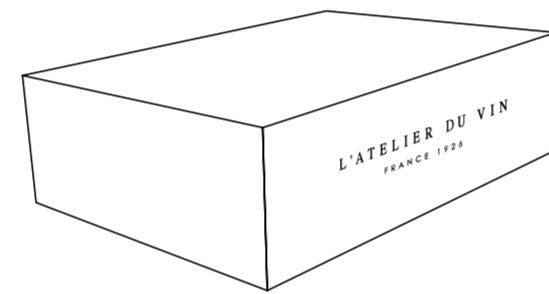

Côté bar à alcools, livres, etc.
On this side: spirits, books, etc.



LAMPE DOUELLE DE TONNEAU
Douelle véritable de tonneau ayant servi plusieurs vins

BARREL STAVE LAMP
Actual barrel stave which harvested several wines

ref : 095348-0



BOUTEILLE TORCHE « TRANSPARENTE » par L'Atelier d'exercices
Bouteille en verre transparent
BOTTLE TORCH LAMP « transparent » by L'Atelier d'exercices
Actual champagne clear glass bottle
ref : 052066-8

BOUTEILLE TORCHE « VERTE » par L'Atelier du Vin
Bouteille en verre
BOTTLE TORCH LAMP « green » by L'Atelier du Vin
Actual champagne glass bottle
ref : 095321-3





LES CAVES

La Cave est ce lieu magique et rêvé, symbole ultime des « vraies » maisons ; même et surtout pour les citadins dont les appartements n'en sont pas toujours pourvus.

Le stockage des bouteilles est un acte d'imagination : où déposer et laisser dormir ses bouteilles, tout en gardant un œil sur elles ? Comment les ranger pour mieux repérer les favorites du jour ?

Nos outils de signalétique et de contrôle, ainsi que nos Unités de stockage modulables transforment la cave en une bibliothèque de vin intelligente.

—

A cellar is a magical place that somehow makes a « real » house, perhaps especially for those of us who live in flats which are rarely equipped with proper cellars.

The storage and organisation of bottles of wine requires some thought. Where and how should they be stored? Will they be safe? How should they be organized so that one can find the required bottle when needed?

Our simple signage devices, information systems and modular Storage units transform the cellar into a smart wine library.



Les Caves/The Cellars : HAUTEUR H2(2.15M)/HEIGHT H2
Verres/Wine glasses : L'EXPLORER CLASSIC

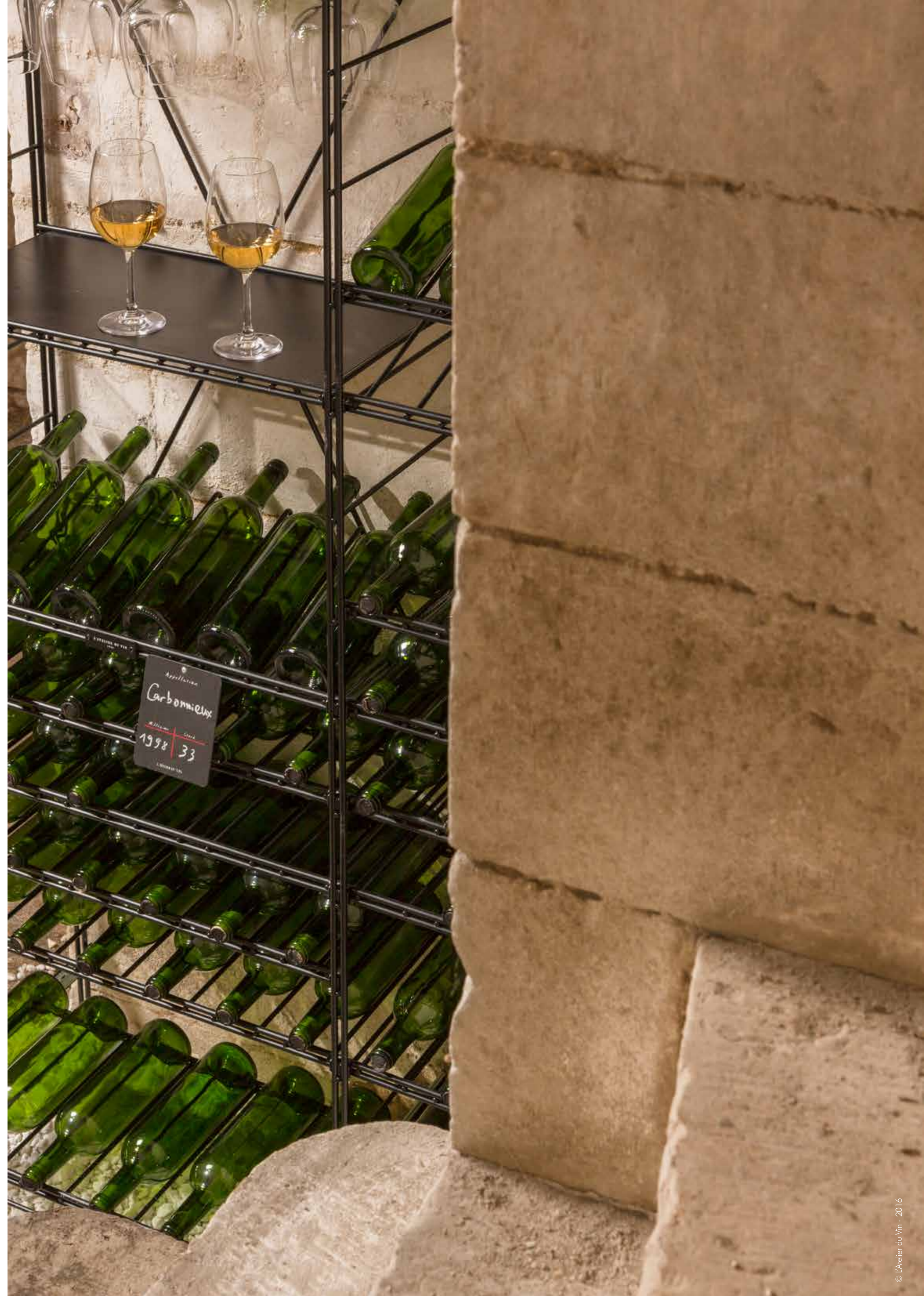



Les Caves/The Cellars : HAUTEUR H2(2.15M)/HEIGHT H2
Lampe/Lamp : BOUTEILLE TORCHE/BOTTLE TORCH LAMP



Plaques signalétiques régions/Region descriptive patches



Station digitale Hydro-thermo/Digital Hydro-thermo Station



Les Caves/The Cellars : HAUTEUR H2(2.15M)/HEIGHT H2
Verres/Wine glasses : L'EXPLORER CLASSIC
Tire-bouchon/Corkscrew : GARÇON

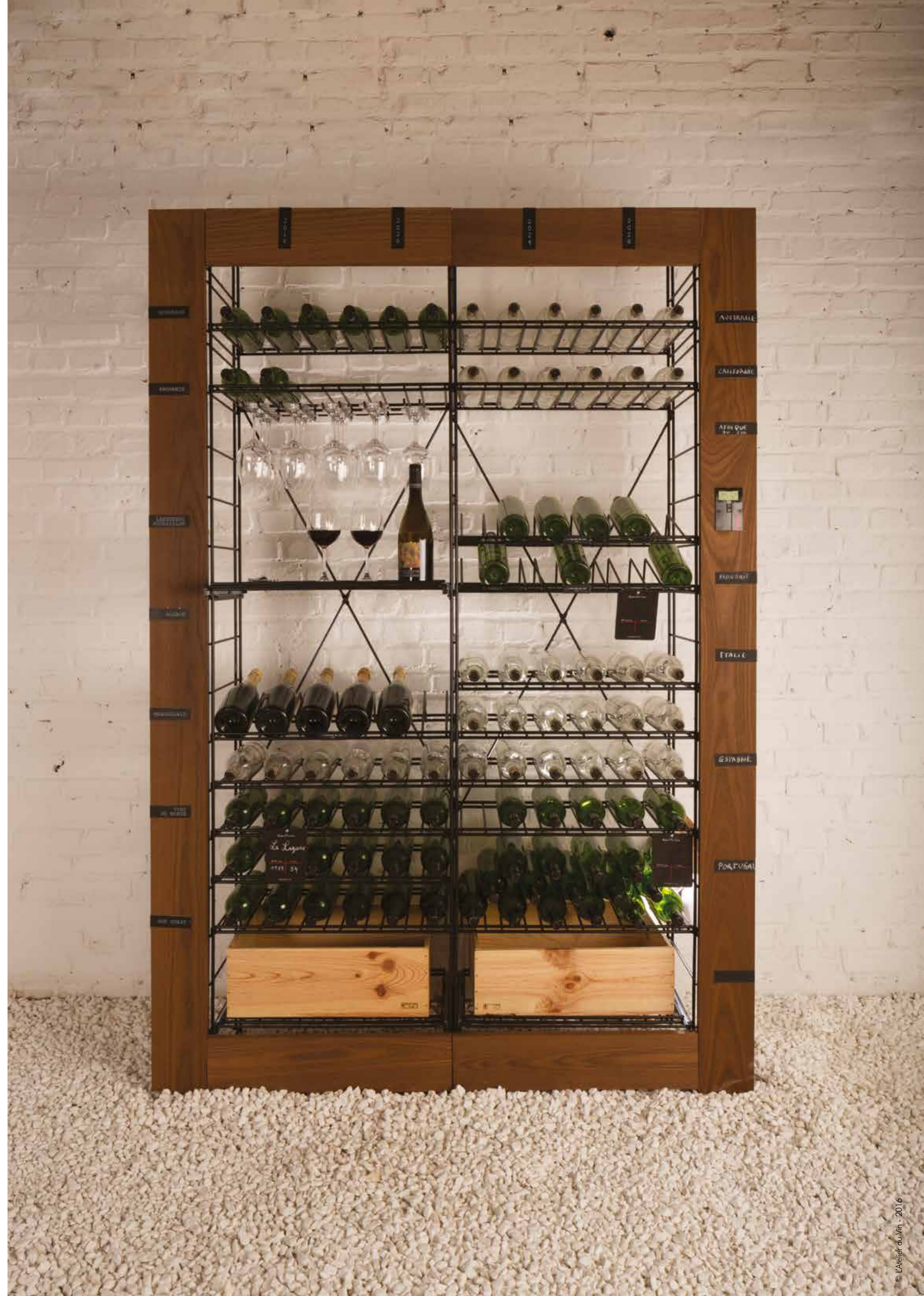



Les Caves/The Cellars : HAUTEUR H2(2.15M)/HEIGHT H2
Verres/Wine glasses : L'EXPLOREUR CLASSIC



Les Caves/The Cellars : HAUTEUR H2(2.15M)/HEIGHT H2



STRUCTURE DE RANGEMENT

Storing unit

HAUTEUR H0 (H100 x L64 x P33 cm) - Height H0

• Module de base H0 (85* bouteilles) avec 3 tablettes
Basic unit H0 (85* bottles) 3 shelves - ref : 095513-2

• Module complémentaire H0 (85 bouteilles) avec 3 tablettes
Complementary unit H0 (85 bottles) 3 shelves - ref : 095514-9

HAUTEUR H1 (H175 x L64 x P33 cm) - Height H1

• Module de base H1 (160 bouteilles) avec 5 tablettes
Basic unit H1 (160 bottles) 5 shelves - ref : 095472-2

• Module complémentaire H1 (160 bouteilles) avec 5 tablettes
Complementary unit H1 (160 bottles) 5 shelves - ref : 095473-9

HAUTEUR H2 (H215 x L64 x P33 cm) - Height H2

• Module de base H2 (185 bouteilles) avec 6 tablettes
Basic unit H2 (185 bottles) 6 shelves - ref : 095474-6

• Module complémentaire H2 (185 bouteilles) avec 6 tablettes
Complementary unit H2 (185 bottles) 6 shelves - ref : 095475-3



*Les capacités de stockage ont été calculées avec des bouteilles de type Bordelaise.



TABLETTES COMPLÉMENTAIRES

Complementary shelves

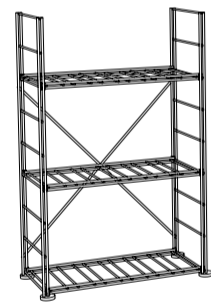

module de base H0

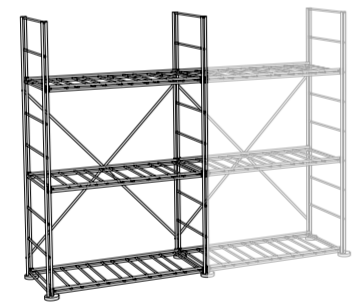

module de base H0
+ 1 module compl.

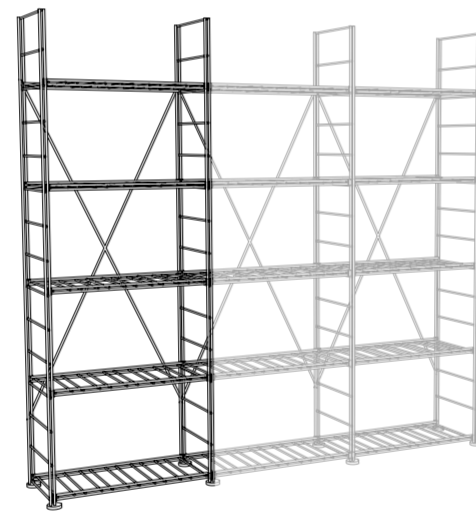

module de base H1
+ 2 modules compl.

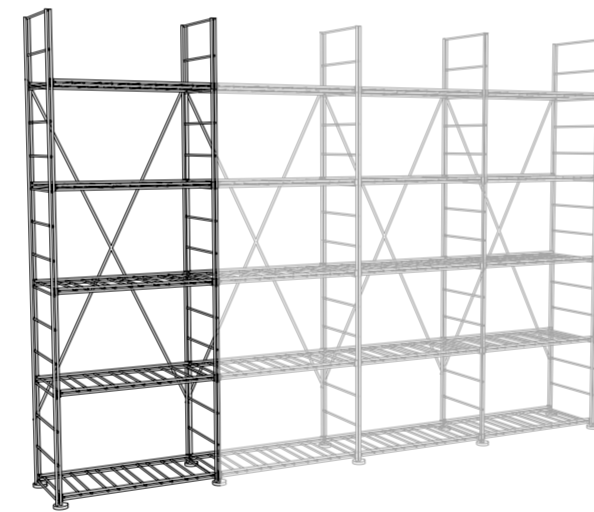

module de base H1
+ 3 modules compl.

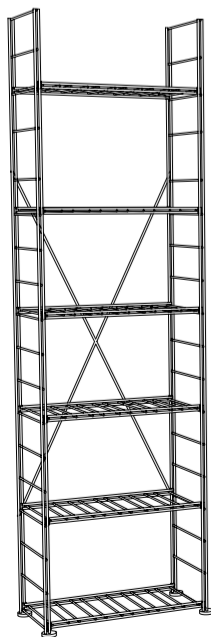

1 module de base H2

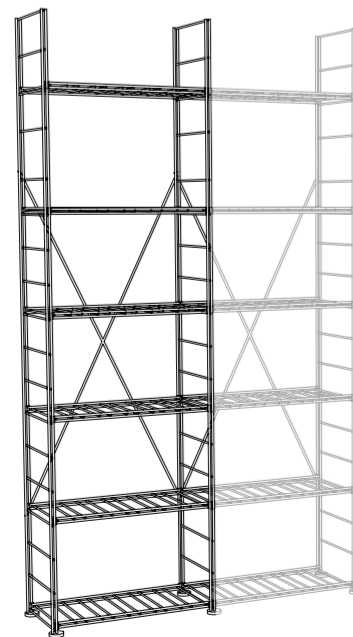

1 module de base H2
+ 1 module compl.

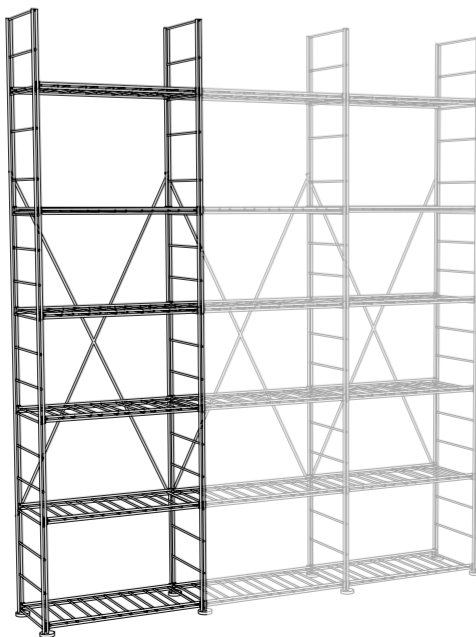

1 module de base H2
+ 2 modules compl.

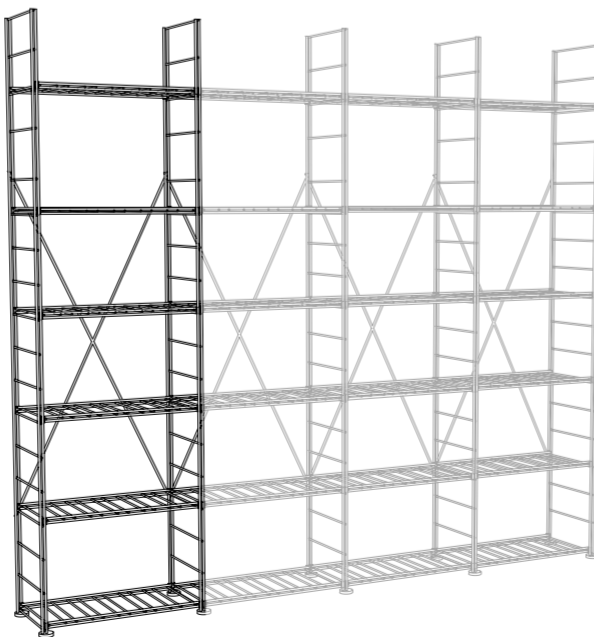

1 module de base H2
+ 3 modules compl.

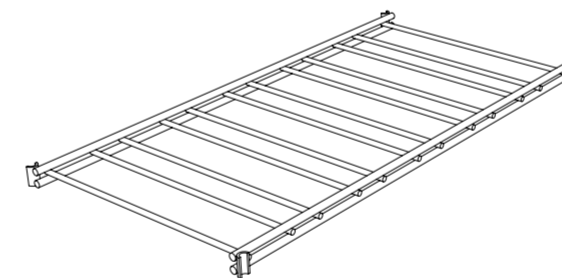

Tablette Horizontale
Shelf - ref : 095272-8

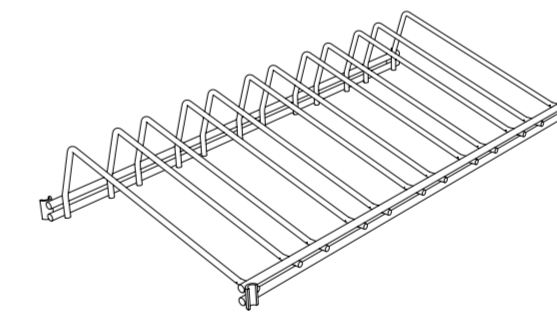

Tablette Inclinée
Slanted Shelf - ref : 095273-5

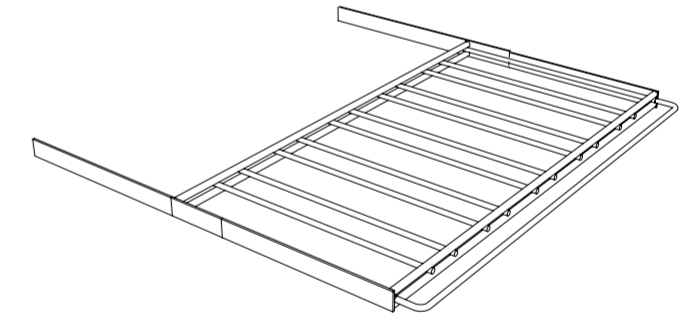

Tablette Tiroir
Drawer Shelf - ref : 095300-8

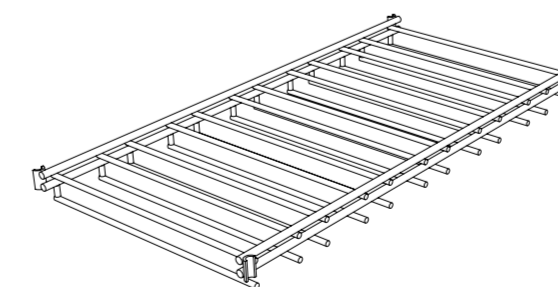

Rack à Verres
Glass rack - ref : 095317-6

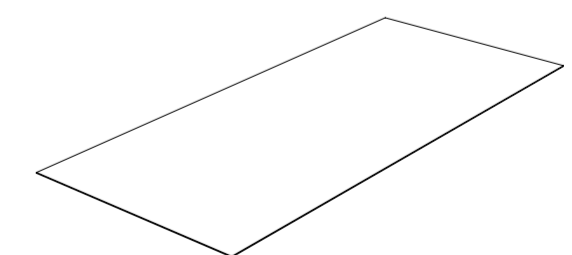

Plaque métal noire mat pour tablette
Matte black metal plate - ref : 095372-6



CADRE EN BOIS Option

Wooden frame

HAUTEUR H1 (1 module : H175 x L87 x P35 cm) - Height H1
 Cadre H1 pour 1 module - ref : 095476-0
 Cadre H1 pour 2 modules - ref : 095477-7
 Cadre H1 pour 3 modules - ref : 095478-4
 Cadre H1 pour 4 modules - ref : 095479-1

HAUTEUR H2 (1 module : H215 x L87 x P35 cm) - Height H2
 Cadre H2 pour 1 module - ref : 095480-7
 Cadre H2 pour 2 modules - ref : 095481-4
 Cadre H2 pour 3 modules - ref : 095482-1
 Cadre H2 pour 4 modules - ref : 095483-8

OPTIONS

12 plaques signalétiques vierges + Stylo-feutre
 12 blank descriptive patches + marker - ref : 095293-3

6 plaques signalétiques années
 6 year descriptive patches - ref : 095283-4

12 plaques signalétiques régions
 12 region descriptive patches - ref : 095282-7



COMPOSANTS

Spare parts

Echelle H0 (1 m) - Ladder H0 - ref : 095356-5
 Echelle H1 (1,75m) - Ladder H1 - ref : 095271-1
 Echelle H2 (2,15m) - Ladder H2 - ref : 095392-3
 Kit d'arrimage - Safety kit - ref : 095426-5
 Croisillons H0 - Cross bars - ref : 095362-6
 Croisillons H1 ou H2 - Cross bars - ref : 095274-2
 Station digitale hygro-thermo
 Hygrometer and thermometer station - ref : 095225-4

Clips d'assemblage « dos à dos »
 Assembly clips for « back to back » units - ref : 095393-0

6 ardoises à clipser
 6 removable cellar cards - ref : 095416-6

80 Disques de cave
 80 cellar disks - ref : 095043-4

Bouteille torche « verte » by L'Atelier du Vin
 Bottle torch lamp by L'Atelier du Vin - ref : 095321-3

Bouteille torche « transparente » by L'Atelier d'exercices
 Bottle torch lamp by L'Atelier d'exercices - ref : 052066-8

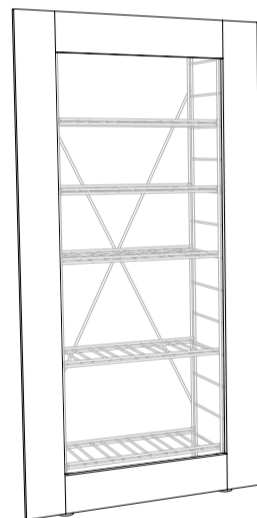

1 cadre H1 pour 1 module.

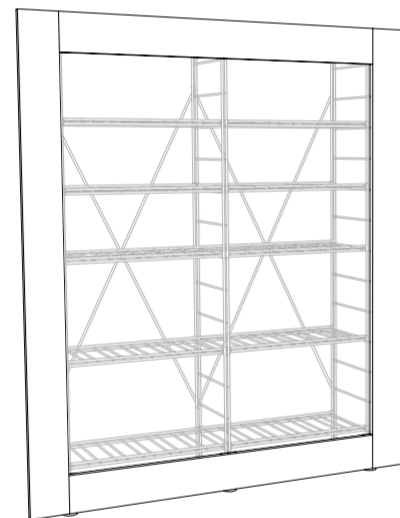

1 cadre H1 pour 2 modules.

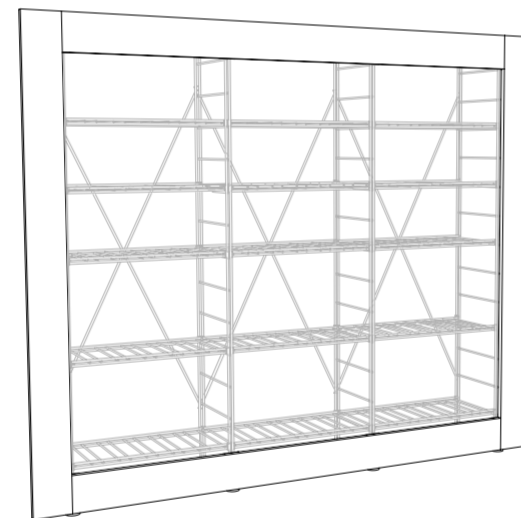

1 cadre H1 pour 3 modules.

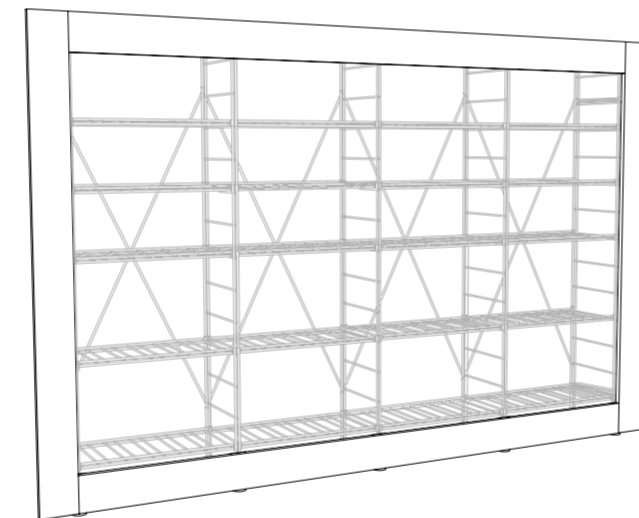

1 cadre H1 pour 4 modules.

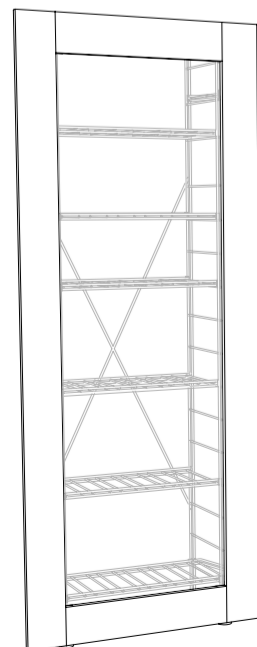

1 cadre H2 pour 1 module.

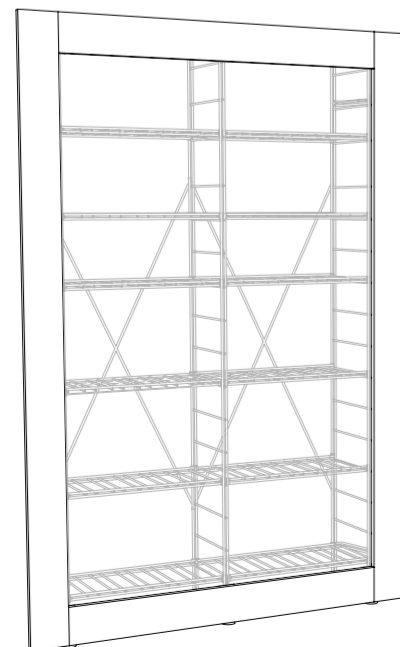

1 cadre H2 pour 2 modules.

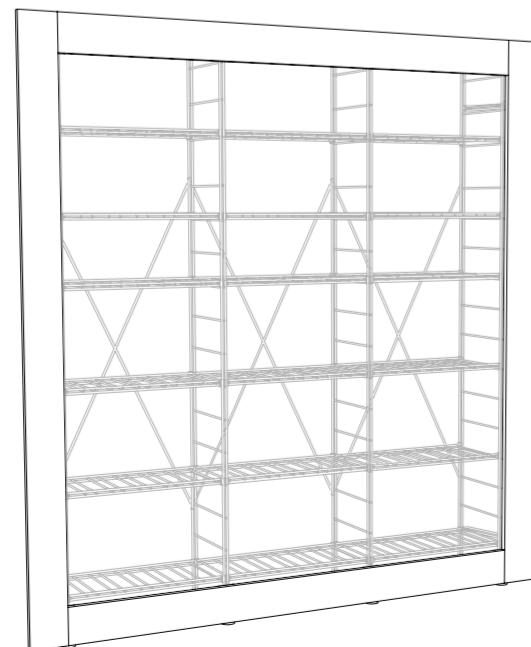

1 cadre H2 pour 3 modules.

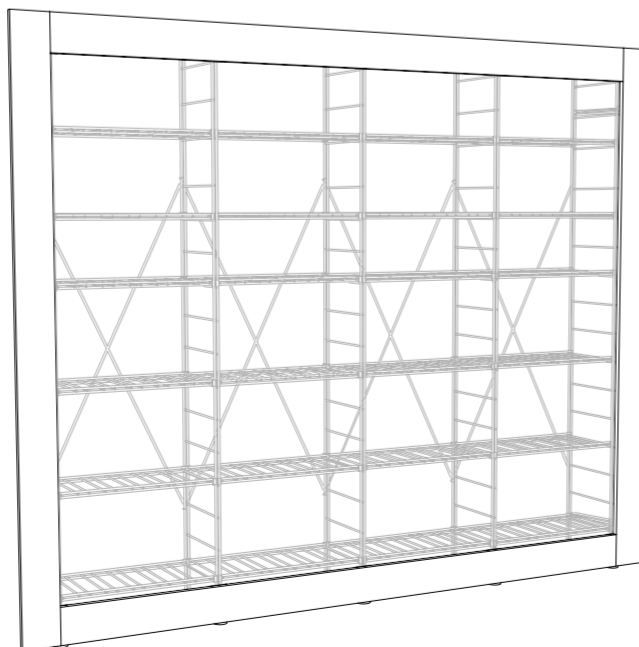

1 cadre H2 pour 4 modules.



Bouteille torche « verte »
 par L'Atelier du Vin
 Bottle torch lamp by L'Atelier du Vin
 ref : 095321-3



80 Disques de cave
 80 Cellar disks
 ref : 095043-4



6 Ardoises à clipser
 6 Removable cellar cards
 ref : 095416-6



Station digitale hygro-thermo
 Hygrometer and Thermometer station
 ref : 095225-4



12 plaques signalétiques régions
 12 region descriptive patches
 ref : 095282-7



VOTRE CAVE SUR MESURE

Your custom-made cellar



1 DIMENSIONS DE VOTRE ESPACE

Cellars measurements

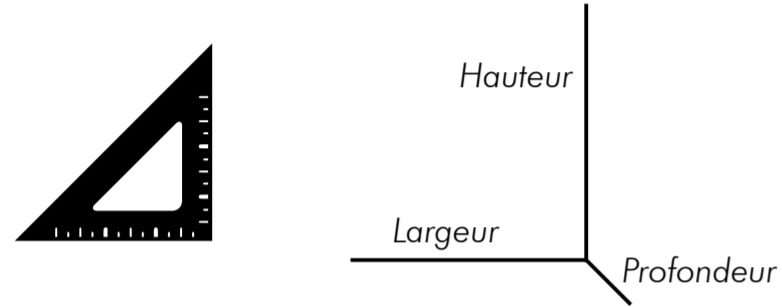

3 CHOIX DES OPTIONS

Options



2 CAPACITÉ SOUHAITÉE EN NOMBRE DE BOUTEILLES

Wished storage capacity (number of bottles)



ex : 250, 800 bouteilles...

4 PRISE DE CONTACT

Contact



TRANSPORT À PLAT

Flat transportation

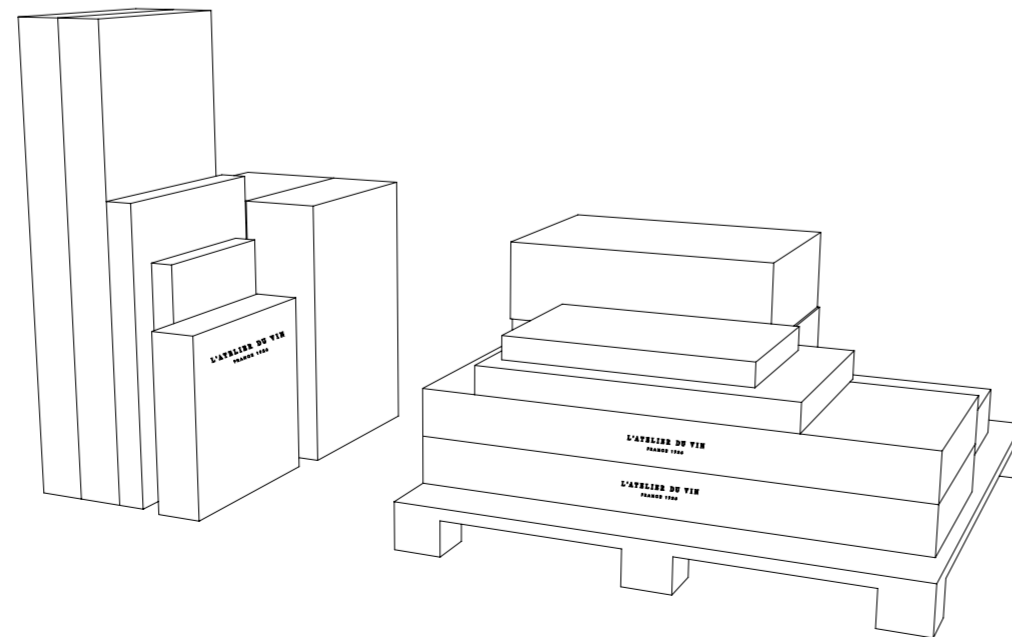

MONTAGE FACILE ET RAPIDE

Simple and fast mounting



Système de montage simple, 95% sans outil, par emboîtements et clipsages.
Simple mounting system, 95% without tools, by interlocks and clipping.

Pieds de réglage pour adaptation aux petites variations de sol.
Adjustable legs to fit any floor unevenness.

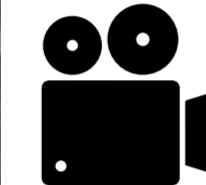

Tutoriel-vidéo de montage : www.atelierduvin.com
Assembly video-tutorial : www.atelierduvin.com

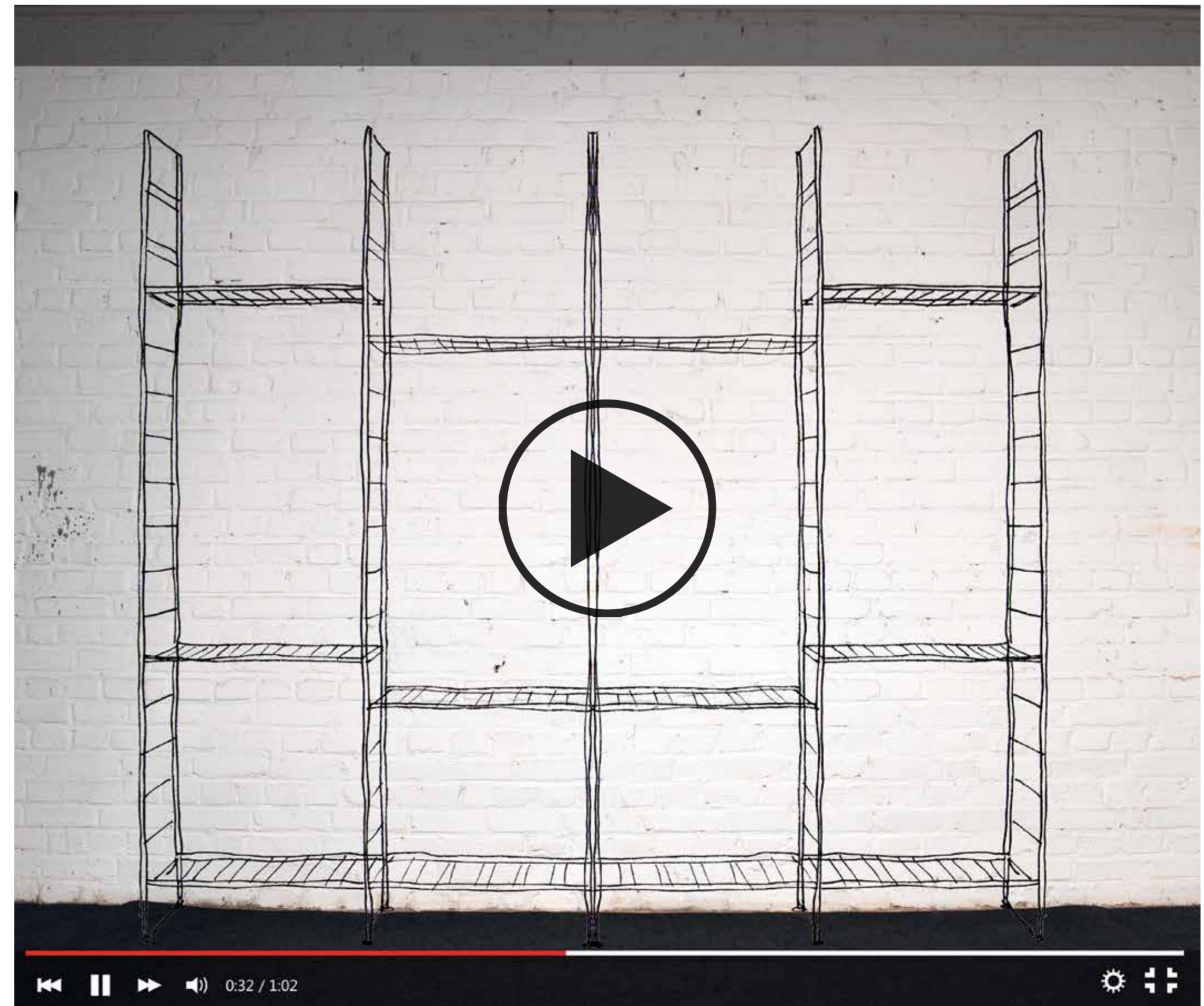



CAVES & LIEUX MARCHANDS

Cellars & Shops

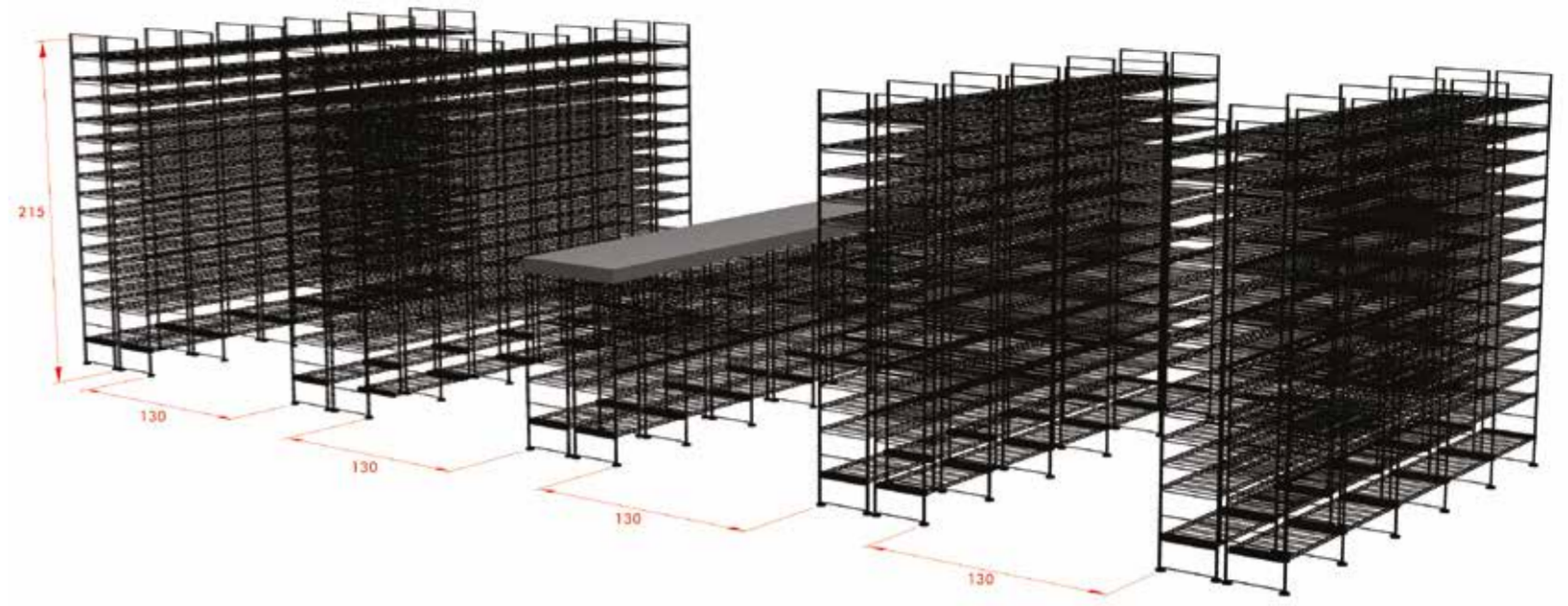

Pick & Go concept

